



A Division of Dura Automotive Systems
 1120 North Main Street • Elkhart, IN 46514
 PHONE: 574•264•2131 FAX: 574•262•2550
 INTERNET: http://www.atwoodmobile.com



LITERATURE NUMBER MPD 87920

**WIRELESS
 REMOTE CONTROL**

ENGLISH

•Installation •Operation •Maintenance

SAFETY ALERT SYMBOLS

Safety Symbols alerting you to potential personal safety hazards.
 Obey all safety messages following these symbols.

WARNING
 avoid possible injury or death

CAUTION
 avoid possible injury and/or property damage

Refer to MPD 87903 and 71125 for complete installation, operation, maintenance and safety instructions for camper jacks and landing gear respectively.

FOR YOUR SAFETY

READ ALL INSTRUCTIONS BEFORE OPERATING

Installer: Provide these instructions to the consumer.
Consumer: Keep documents for future reference.

Our remote control is designed for use only with Electric Ball Screw Truck Camper Jacks (EBSTCJ) equipped for remote control capability and Atwood Landing Gears. Atwood makes two types of EBSTCJ; one with remote capability and one without; they are not interchangeable.

**WARNING
 PERSONAL INJURY & PRODUCT DAMAGE**

- To deactivate the wireless system when you are finished press the Activation Switch.
- Only operate jacks when camper is unoccupied and contents are secured and properly distributed.
- Maintain proper load distribution and a safe distance when raising or lowering camper.
- Store remote in a secure place, away from access by children.
- Remove the battery from the handheld remote before storing to prevent accidental jack activation or continuous remote transmission. If the remote is continuously activated by a jammed or shorted button, operation of other remote devices such as vehicle keyless entry systems and/or garage door openers may be interfered with or prevented.

SPECIFICATIONS:

DESCRIPTION	SPEC	DESCRIPTION	SPEC
Channels:	1	Power Source:	9-volt alkaline battery
Frequency:	315 MHz	Weight:	4.0 ounces
Operating Temp. Range:	-20°C to 120°C		

FCC Compliance Statement - Remote Control P/N 85442

This device complies with Part 15 of the FCC Rules. Operation is subject to the following two conditions: (1) this device may not cause harmful interference, and (2) this device must accept any interference received, including interference that may cause undesired operation.

You do not need an FCC license to operate the wireless remote. However, any changes or modifications to the device will void the user's authority to operate the equipment.

**WARNING
 EXPLOSION**

- To avoid possible interference with blasting operations, do not use your remote near ELECTRICAL BLASTING CAPS or in a BLASTING AREA or in areas posted: **TURN OFF TWO-WAY RADIO.** Obey all signs and instructions.
- Do not use the remote near explosive atmospheres.

Explosive atmospheres are often, but not always, clearly marked. They include fueling areas, fuel or chemical transfer or storage facilities: areas where the air contains chemicals or particles, such as grain, dust, or metal powders, and any other area where you would normally be advised to turn off your vehicle engine.

INSTALLATION

**CAUTION
 PRODUCT DAMAGE**

- Disconnect power to the power relay module prior to HiPot testing of the camper or the microprocessor will be damaged.

1. Install the power relay module in a clean, dry interior area protected from moisture. Use the four (4) 5/32" diameter holes for mounting the module base. Position the base on the mounting surface and secure it using appropriate hardware for the wall material. Orient antennae in the position shown (FIG 5 & 6-L). Permanently secure antenna to mounting surface with appropriate hardware (FIG 5-P).

**CAUTION
 PRODUCT DAMAGE**

- Failure to orient antennae properly will result in intermittent operation of the wireless remote system.

NOTE: Correct polarity must be observed as noted on the circuit board next to 5 & 6-H. The unit will not function if the input power is installed in reverse polarity. See FIG 5 & 6.

- | | |
|------------------------------------|------------------------------------|
| A - Driver Front Jack or Leg | F - Red (-) Motor Gear Box Lead |
| B - Passenger Front Jack or Leg | G - Yellow (+) Motor Gear Box Lead |
| C - Driver Rear Jack or Leveleg | H - Input Power Terminal Block |
| D - Passenger Rear Jack or Leveleg | I - Jack Terminal Block |
| E - *40 AMP Circuit Breaker | J - Flat Cable |
| *For all camper jacks | K - Dip Switches |
| or 60 AMP resetable | L - Antenna |
| circuit breaker for | M - Male Connector |
| 8AWG battery wire. | N - Female Connector |
| | O - 30 AMP Fuses |

2. **SUPPLY POWER TO UNIT:** The unit operates from a +12 VDC battery and must be supplied through a 40 AMP circuit breaker (FIG 5E & 6-E). Route the #8 AWG, +12 VDC from the circuit breaker and the ground wiring, to the terminal block (FIG 5H & 6-H). Terminate the wires in the labeled positions and tighten the screws with 16-18 in-lbs of force.
3. Route the two #10 AWG wires from each jack to the terminal block 5-I & 6-I. Refer to the labels next to each terminal position for driver front, passenger front, driver rear, and passenger rear jacks. Terminate the wires for each jack and tighten the screws with 12-13 in-lbs of force.
4. Install the Activation Switch near the floor just inside the door of the pickup camper (FIG 5-Q) or in an outside compartment of the fifth wheel. Plug the flat cable into the left side of the power relay module (FIG 5-J & 6-J) and route to the location of the activation switch (FIG 5 & 6-Q). Plug other end of the cable into the back side of the activation switch.

NOTE: The Key Fob control has an Activate/Learn button on the relay module instead of a separate Activation Switch.

SET UP OF WIRELESS REMOTE



WARNING

PERSONAL INJURY & PRODUCT DAMAGE

- Do not replace or charge batteries in a potentially explosive atmosphere. Contact sparking may occur while installing or removing batteries and cause an explosion.
- All batteries can cause property damage and/or bodily injury such as burns if a conductive material such as jewelry, keys or beaded chains touches exposed terminals. The material may complete an electrical circuit (short circuit) and become quite hot. Exercise care in handling any charged battery, particularly when placing it inside a pocket, purse or other container with metal objects.

LARGE REMOTE BATTERY INSTALLATION:

- Firmly slide battery cover (remote back) down to remove.
 - Insert one 9V battery.
 - Replace the battery cover and slide up until secure.
- The battery type is 9V alkaline battery which will provide approximately 45 minutes of continuous use.

KEY FOB BATTERY INSTALLATION:

- Using a Phillips small tip screwdriver, remove the screw at the bottom of the key fob remote.
- Using a standard (thin) blade screwdriver carefully pry apart the two halves of the remote case.
- Carefully lift the front half of the case away from the bottom case to expose the circuit board and battery.
- The battery is type 23, (12 volt). Remove the battery from the holder making note of the polarity. Install the new battery into the case and re-assemble the enclosure and install the screw.

NOTE: Remove batteries before storing your remote for extended periods. Batteries corrode over time and may cause permanent damage to your remote.

DIP SWITCHES

The wireless remote and power relay module are equipped with dip switches. For the unit to operate, the switches in both units must be set to the same code.

NOTE: The code for all units is preset at the factory prior to delivery. If you frequently camp next to other RV's equipped with the Atwood remote control set the remote and power relay to a unique code to avoid actuating other campers near you.

TO SET DIP SWITCHES:

NOTE: Key Fob does not have dip switches.

POWER RELAY MODULE - Determine a code and record it. Locate the dip switches (FIG 4-K & 6-K). To set the dip switches, slide the individual dip switch to the up position which is ON or keep in the down position which is OFF. Dip switches can be moved easily with a ball point pen or other small pointed instrument.

REMOTE - Using a phillips screw driver, remove the four screws in the four corners of the remote. Take off the back cover to expose the dip switches (FIG 4-A insert). Set the dip switches to the same code as the power relay module. Replace the back cover and install the four screws. Ensure the screws are evenly tightened.

OPERATION



WARNING

CAMPER CAN TIP OVER

- Park the camper on a firm, level site.
- Area below and around jacks must be clear of obstructions.
- Do not place blocks under the jack for additional ground clearance.
- Always keep the front of camper higher than or equal to the rear of the camper. Never allow either side or end of camper to be more than 4" out of level (FIG 2 and 3).
- Maintain proper load distribution and a safe distance when raising/lowering coupler.

- Remove the hand held remote control from its secure compartment.
- Press Activation Switch or Activate/Learn Button. The switch has an automatic off circuit that times out after 10 minutes.
- When finished, the LED on the activation switch must not be lit.

CAUTION PRODUCT DAMAGE

- Do not over-extend or over-retract jacks. The electric jack has an internal slip clutch to help prevent damage; when clicking sound is heard, release switch. Continuing to hold the switch will wear out the slip clutch or cause damage to the motor.

TRUCK CAMPER

TO LIFT

EXTEND FRONT JACKS FIRST



Extend front jacks so camper is 4" higher in front than in the rear. (FIG 2).

EXTEND ALL JACKS



Once the camper front is higher than the rear, press and hold the ALL JACKS BUTTON, extend (E). Release when the camper is at the desired height.

INDIVIDUAL JACK ADJUSTMENT

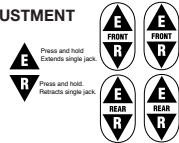

Use the individual jacks buttons to adjust an individual jack. NOTE: A maximum of two individual jacks can be operated at any time. Press and hold the extend or release buttons for the individual jacks as needed to keep the front of the camper 4" higher than the rear, to prevent tipping over the camper. Keep all corners within 4" of level with each other.



WARNING

PERSONAL INJURY & PRODUCT DAMAGE

- Do not enter camper after it is removed from truck until it is lowered to its lowest position. This will minimize sway which could cause structural damage to the camper, jacks or injury to persons.

TO LOWER

RETRACT REAR JACKS FIRST



Retract rear jacks so camper is 4" lower in rear than in the front. (FIG 3).

RETRACT ALL JACKS



Once the camper has the rear lower than the front, press and hold the ALL JACKS BUTTON, retract (R). Release when the camper is at the desired height.

INDIVIDUAL JACK ADJUSTMENT



Use the individual jacks buttons to adjust an individual jack. NOTE: A maximum of two individual jacks can be operated at one time. Keep all corners within 4" of level with each other.

REMOVING CAMPER FROM TRUCK

Disconnect electrical connection between camper and truck (refer to your camper operation instructions or contact the camper manufacturer for more information). Follow the instructions from the "TO LIFT" or "TO LOWER TRUCK CAMPER" sections and FIG 2 and 3. Raise camper until bottom of camper clears truck bed. Slowly drive truck from underneath camper. Lower camper to lowest possible position without any part of camper touching the ground.

LOADING CAMPER ON TRUCK

Following the instructions "TO LIFT" or "TO LOWER" truck camper sections and FIG 2 and 3, raise camper high enough to clear truck bed. Carefully back truck under camper making sure not to damage any portion of the camper or jacks. Camper should be centered in truck bed with front of camper as far forward in truck bed as possible. Attach electrical connections between truck and camper, (refer to your camper operating instructions or contact the camper manufacturer for further information). Lower camper into truck bed, then fully retract all jacks.

Manual Override Operation: To manually extend or retract jack, unplug jack from camper to disable the jack motor's dynamic brake. Place manual override handle (FIG 1-A) into alignment tube (FIG 1-B) and engage drive pin. Rotate handle counter-clockwise to raise or clockwise to lower camper. Plug the jack back into camper to activate the jack motor's dynamic brake.

5TH WHEEL TRAILERS

1 MOTOR SYSTEM (KEY FOB)

TO LIFT

1. Remove the hand held remote control from its secure compartment.
2. Press activate/learn button until red LED illuminates, then release.
The button has an automatic off circuit that times out after 10 minutes. It can be turned off at any time.

EXTEND ALL LEGS		Press and hold this button. Release when the kingpin is at the desired height.
-----------------	---	---

TO LOWER

Retract slideout rooms fully to their inboard position.
Press the activate/learn button to turn on remote control.

RETRACT ALL LEGS		Press and hold this button. Release when the legs are retracted.
------------------	---	---

TO PROGRAM REPLACEMENT KEY FOB

If you have a replacement key fob, it must be programmed to the receiver.

1. Remove the hand held remote control from its secure compartment.
2. Press activate/learn button until red LED illuminates, then release.
The button has an automatic off circuit that times out after 10 minutes. It can be turned off at any time by pressing activation button again.
3. Press and hold the Red Activate/Learn Switch for approximately 5 seconds until the LED begins to flash. The receiver is in the transmitter code learning mode. All previous programs are erased.
4. Press any button on the transmitter (remote) and verify the Red LED on the receiver stays lit for approximately 1/2 second, then returns to the flashing modes of illumination. This indicates the transmitter is identified by the receiver.
5. Repeat step 4 for additional transmitters that will be used with the receiver.
6. If there are no additional transmitters to be programmed, in 5 seconds the Red LED will return to constant illumination and the receiver to normal operation.
7. Verify the remote is programmed with the receiver by pressing any button on the remote and see if the corresponding function is activated.

2 MOTOR SYSTEM

TO LIFT

1. Remove the hand held remote control from its secure compartment.
2. Press activation switch. The switch has an automatic off circuit that times out after 10 minutes.
3. When finished, the LED on the activation switch must not be lit.
4. **PANIC STOP** - Once the legs start moving, any button can be depressed to panic stop the legs. The system stays activated. Push RETRACT ALL to reset system.

EXTEND ALL LEGS		Press and hold the EXTEND ALL button. Release when the kingpin is at the desired height.
-----------------	---	---

INDIVIDUAL LEG ADJUSTMENT		Use the individual leg button for adjustment. Press and hold the EXTEND BUTTON (▲) for an individual leg as needed until the front of the trailer is level.
---------------------------	---	--

TO LOWER

Retract slideout rooms fully to their inboard position.
Press the activation button to turn on remote control.

RETRACT ALL LEGS		Press and hold the RETRACT ALL button, retract Release when the legs are retracted.
------------------	---	--

INDIVIDUAL LEG ADJUSTMENT		Use the individual leg buttons for adjustment.
---------------------------	---	--

4 MOTOR SYSTEM

TO LIFT

1. Remove the hand held remote control from its secure compartment.
2. Press activation switch. The switch has an automatic off circuit that times out after 10 minutes.
3. When finished, the LED on the activation switch must not be lit.
4. **PANIC STOP** - Once the legs start moving, any button can be depressed to panic stop the legs. The system stays activated. Push RETRACT ALL to reset system.

AUTO EXTEND		Press the AUTO EXTEND BUTTON and all four legs will extend automatically. Upon reaching the ground and sensing a minimum load, the legs will stop.
-------------	---	--

FRONT LEGS		Press and hold the FRONT button to extend the front levelers for 4".
------------	---	--

REAR LEGS		Press and hold the REAR button to extend the rear levelers for 4".
-----------	---	--

INDIVIDUAL LEGS		Press the IND button and the button for the individual leg to make an adjustment as needed.
-----------------	---	---

TO LOWER

Retract slideout rooms fully to their inboard position.
Press the activation button to turn on remote control.

- PANIC STOP** - Once the legs start moving, any button can be depressed to panic stop the legs. The system stays activated. Push RETRACT ALL to reset system.

REAR LEGS		Press and hold the REAR button to retract the rear levelers for 4".
-----------	---	---

FRONT LEGS		Press and hold the FRONT button to retract the front levelers for 4".
------------	---	---

INDIVIDUAL LEGS		Press the IND button and the button for the individual leg to make an adjustment as needed.
-----------------	---	---

Alternate between the REAR and FRONT buttons, **keeping the front of the trailer higher than the rear**. Retract the legs in this manner until all legs are slightly off the ground.

AUTO RETRACT		Once the load is off the legs, press AUTO RETRACT and release. The system will automatically finish the retraction process.
--------------	---	---

MANUAL OVERRIDE: Refer to MPD 71125 for manual operation of landing gear, direct drive legs, or rear levelers.

⚠ CAUTION TRAILER CAN MOVE OR COLLAPSE

- Never exceed rated capacity of landing legs.
- **LANDING LEGS ARE NOT DESIGNED TO BE USED AS TRAILER JACKS.** Do not use the landing legs to lift the trailer during tire changes, axle work or trailer servicing (the trailer weight will exceed the capacity of the landing legs). The landing legs are designed to stabilize a portion of the trailer's weight. Support the front end of the trailer with structural stands rated for the GVWR of the trailer.
- Chock both sides of trailer wheels before operating landing legs
- All legs must touch the ground or the surface at the same time.
- Retract landing legs and levelers completely before towing trailer.

TROUBLESHOOTING

If all or any of the jacks or landing legs fail to operate:

1. Check whether the 12VDC battery is fully charged. You may need to recharge it.
2. Check that the camper jack cords are securely plugged into the exterior sockets. You may need to pull a plug out and replug it.
3. If the motor will not extend/retract the jack and the motor is making a ratcheting sound (clutch slipping), do not use the manual override. Immediately contact an Atwood Service Center and have jack replaced. Do not use the jack until replaced.
4. Assure the activation switch is turned on. The LED on the switch pad should be lit.
5. Hold the hand-held remote vertically with the keypad facing you and have the remote between you and the camper.
6. Check that you are within 20 feet of the camper, however at a safe distance to avoid contact with the camper. All observers must also be at a safe distance.
7. Replace the 9V battery
8. Check that the battery terminals are clean and have no corrosion.
9. Be sure the dip switch code for the remote and the power relay module are set for the same code.
10. Look to see if other radio frequency devices such as an automobile key fob, cellular phone, TV remote control, are operating within range of your remote.

These devices will make the jacks pause. Lift your finger from the button on the remote and re-press the button.

If the jacks keep running, push the activation switch and the light on the switch will go out. This will shut the power off to the jacks. If not, unplug the jack(s) from its (their) exterior socket(s).

MAINTENANCE

1. To clean the remote, wipe with a soft cloth dampened with water. Don't use cleaners or solvents on the remote, they can harm the body and leak inside, causing permanent damage. Battery contacts may be wiped with a dry, lint-free cloth.
2. If the remote gets wet, remove batteries immediately. Dry battery compartment with a soft cloth to minimize potential water damage. Leave cover off the battery compartment overnight or until completely dry. Do not use the remote until completely dry.
3. If power relay module gets wet, turn off circuit breaker to the unit. Allow unit to fully dry before attempting to use it.
4. If it is not possible to get jack to operate freely, replace jack.
5. Should problems or questions arise, contact your dealer, the camper manufacturer, or the Atwood Service Department (574) 262-2655.
6. The ball screw jacks and remote controls have a two year warranty as written in this manual. For more warranty information contact Atwood before having any work done.

ATWOOD LIMITED WARRANTY

Atwood Mobile Products warrants to the retail owner and subject to the below mentioned conditions, that this product will be free of defects in material or workmanship for a period of two years from the original date of purchase. Atwood's liability hereunder is limited to the replacement of the product, repair of the product, or replacement of the product with a reconditioned product at the discretion of the manufacturer. This warranty is void if the product has been damaged by accident, unreasonable use, neglect, tampering or other causes not arising from defects in material or workmanship. This warranty extends to the original owner of the product only and is subject to the following conditions:

1. For two (2) years commencing with the date of purchase, Atwood will provide the replacement or repair of any Hardware System and Components that are found to be defective by Atwood in material or workmanship.
2. **In the event of a warranty claim, the original owner must contact the Atwood Consumer Service Department, 1120 North Main, Elkhart, IN 46514 USA. Phone: (574-262-2655).** Warranty Claim Service must be performed as approved by the Atwood Consumer Service Department. Warranty replacement hardware systems and components or parts will be furnished freight prepaid labor cost to repair or replace will be limited to the amount of the original purchase price of the systems and components. The replaced warranty products or parts become the property of Atwood Mobile Products and must be returned to the Atwood Consumer Service Department freight prepaid, unless prior arrangements have been made.
3. This limited warrant is valid only when the product is applied, installed, maintained and operated in accordance with this Atwood Installation Maintenance and Operating Manual. Any deviation from these specifications must be approved in writing by Atwood.
4. ANY IMPLIED WARRANTIES arising by way of State Law, including any implied warranty of merchantability and any implied warranty of fitness for a particular purpose are limited in duration to the term of this Limited Warranty. Atwood makes no further warranty of any nature beyond this Limited Warranty. No person has authority to enlarge, amend or modify this Limited Warranty.
5. Any action to enforce this warranty shall not be commenced more than one (1) year after the expiration of this warranty.

5.22.07

PICKUP CAMPERS

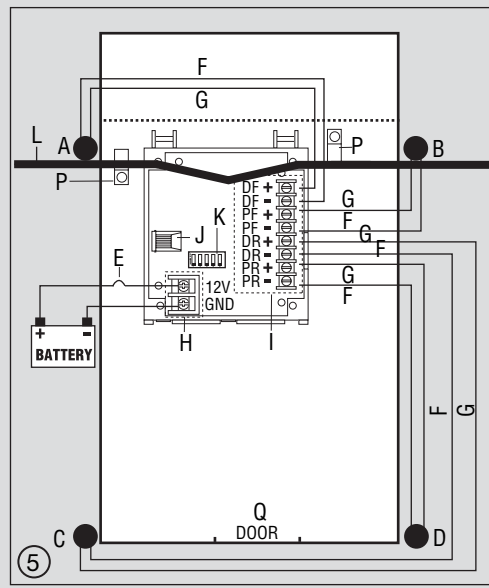
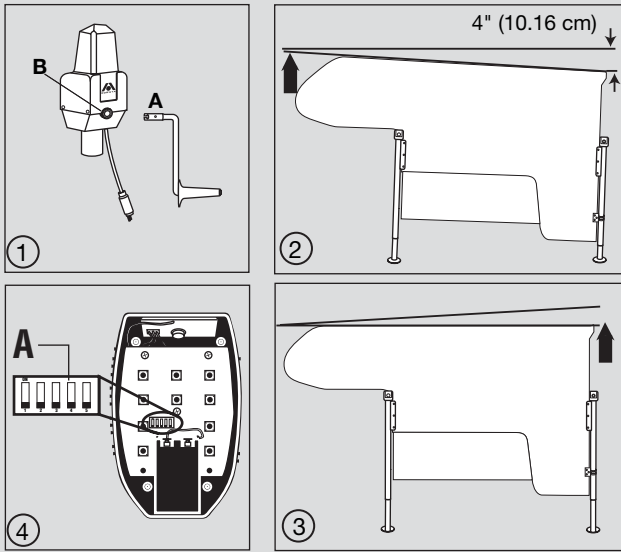

6 5th WHEEL TRAILERS

Control Boards

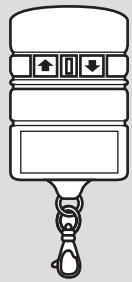

KEY FOB

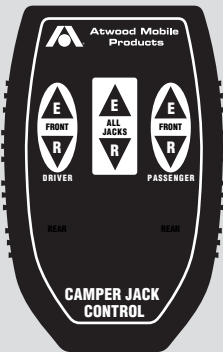

2- MOTOR

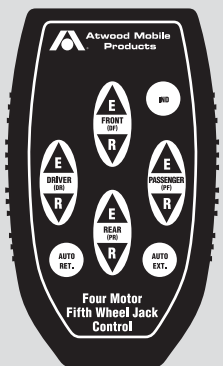

4- MOTOR

