

# Atwood XT<sup>®</sup> Water Heaters

Advanced Water Heater System Featuring Exothermal Technology

**The Intelligent  
Way to Deliver  
More Hot Water!**

**The Equivalence  
of a 16-Gallon  
Water Heater!**

**H<sub>2</sub>O<sup>T</sup>**

**Atwood XT<sup>®</sup>**

Advanced Water Heater System Featuring Exothermal Technology



EFFECTIVE DECEMBER 2007



# Atwood XT® Water Heaters—The Intelligent Way to Deliver More Hot Water!



10 gallon & 6 gallon models available

**Albert Einstein taught us that the best solution is often the simplest solution!**

Our competitors have been making bigger, bulkier, heavier water heaters to provide more hot water.

Atwood engineers, however, thought a better solution would be to design a water heater that provides 50% more hot water without increasing the size or adding weight!

In this case, the simplest, and best, solution is to give both the RVer and the RV manufacturer what they want!

**Atwood XT® — The Intelligent Way to Deliver More Hot Water!**

## The Atwood XT® Provides the Equivalence of a 16-Gallon Water Heater!

**Save Money**—The Atwood XT® comes pre-configured for installation with a winterizing bypass capability, reducing OEM's installation expense. The Atwood XT® can also be installed in the same cut-out space as the current, popular Atwood Water Heater, saving OEMs the expense of having to redesign their coaches to accommodate for bigger, bulkier, heavier water heaters.

**Save Time**—The Atwood XT® pre-configured winterizing capability eliminates one additional, time-consuming installation step. The valve, hose, tee, and thermostatically-controlled mixing valve, with a check valve and a cold water passage, allows you to isolate and drain the tank and pump antifreeze through the plumbing circuit. Because Atwood has greatly increased hot water output while maintaining the size and weight of the water heater, OEMs can simply install the Atwood XT® in the same cut-out dimension that they have grown accustomed to!

**Save Weight**—A comparable 16-Gallon water heater would weigh about 50 pounds more with the weight of 6 gallons of water and the additional material needed to build a larger water heater than the 10-gallon XT. The Atwood XT® uses Exothermal Technology to provide the equivalence of 16-Gallons of hot water while maintaining the same weight as the best-selling, popular Atwood Water Heaters the industry has grown accustomed to. A comparable 9-gallon water heater would weigh about 25 pounds more than the 6-gallon XT.

**Save Space**—Atwood's Exothermal Technology has increased the hot water output of the Atwood XT® Water Heater, not the size of the water heater! While some manufacturers are trying to provide additional hot water by creating bigger, bulkier, heavier water heaters, Atwood provides a more efficient solution—

**Atwood XT® — The Intelligent Way to Deliver More Hot Water!**



**Antonio Stradivarius taught us that there is no substitution for quality!**

For centuries, violin makers tried to make violins comparable to those produced by Stradivarius, but to no avail. Likewise, for decades, competitors have challenged Atwood as the dominant provider of water heaters to the RV industry.

Today, while the *New Atwood XT®* employs technology to provide RVers with 50% more hot water, it also takes advantage of a long history of being part of the best-selling, most popular Atwood water heater product line. This ensures that not only do RVers enjoy additional hot water, but RV manufacturers can provide it without making expensive and time-consuming coach design alterations!

**Atwood XT® — The Intelligent Way to Deliver More Hot Water!**

## Atwood XT® Water Heater Selection Guide

Model No.	OEM Part No.	AfterMarket Part No.	Capacity	Energy Source		Input		Recovery Gallons per Hour		Unit Weight Pounds			
				Gas	Electric	Exchanger	Gas 8,800 BTU	Gas 10,000 BTU	Electric 1400 Watt	Gas	Electric	Gas/Electric	Empty
<b>ATWOOD XT WATER HEATER</b>													
G9EXT	90074	90073	6	•						11.5		21	70
GE9EXT	90072	90071	6	•	•					11.5	6.2	17.7	72
GEH9EXT	90069	90068	6	•	•	•				11.5	6.2	17.7	72
G16EXT	94103	94105	10	•			•			13.5		26	107
GE16EXT	94024	94026	10	•	•		•			13.5	6.2	19.7	109
GEH16EXT	94027	94029	10	•	•	•	•			13.5	6.2	19.7	109

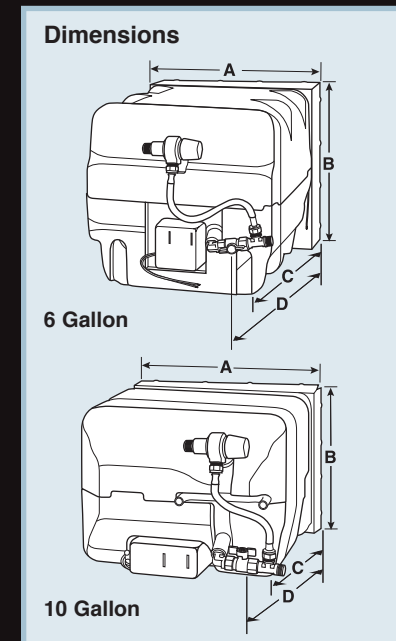
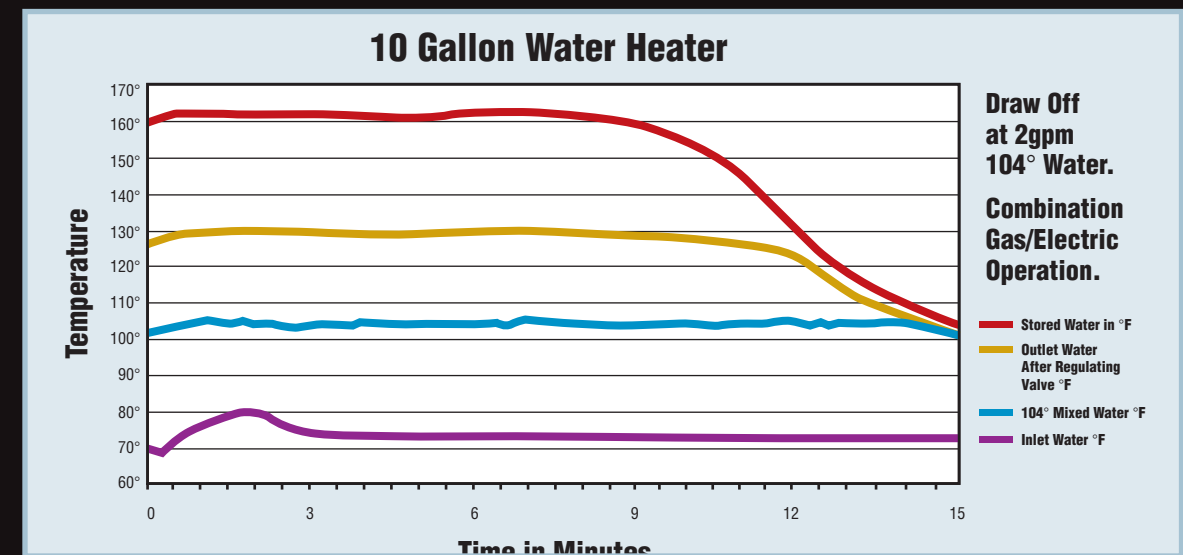

<b>ATWOOD XT WATER HEATER DIMENSIONS</b>							
A		B		C		D	
in.	mm	in.	mm	in.	mm	in.	m
<b>10 GALLON</b>							
16	406.4	15.5	393.7	19.7	500.4	21.75	552.
<b>6 GALLON</b>							
16	406.4	12.5	317.5	16.5	419.1	19.5	495.3
<b>ATWOOD XT WATER HEATER SHIPPING SPECIFICATIONS</b>							
Shipping Wt.		Carton Depth		Carton Width		Carton Height	
lbs.	kg	in.	mm	in.	kg	in.	mm
<b>10 GALLON</b>							
32	14.5	20.5	520.7	20.25	514.35	22.75	577.85
<b>6 GALLON</b>							
27	12.3	17.25	438.15	20.25	514.35	21.5	546.1

PATENT PENDING





# Atwood® Products

Atwood Mobile Products offers a wide range of products for many markets including, but not limited to, the Recreation Vehicle, Agricultural, Commercial, Industrial, and Marine industries. Product literature is available by calling 574-264-2131 or asking your regional salesperson.

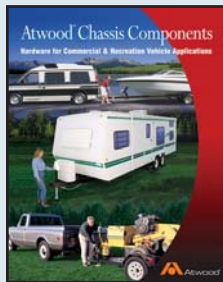

## Atwood® Chassis Components

- Agricultural
- Commercial
- Industrial
- Marine
- Recreation Vehicles

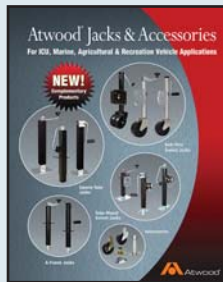

## Atwood® Jacks & Accessories

- Agricultural
- Commercial
- Industrial
- Marine
- Recreation Vehicles

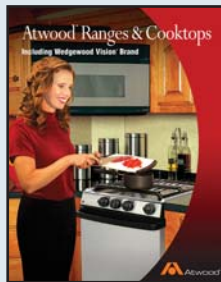

## Atwood® Ranges & Cooktops

- Recreation Vehicles

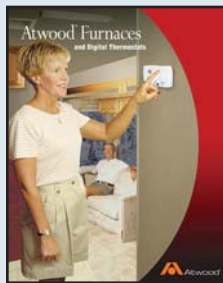

## Atwood® Furnaces

- Recreation Vehicles
- Marine

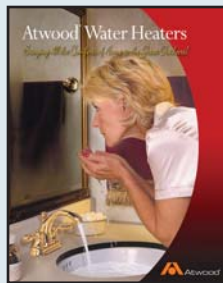

## Atwood® Water Heaters

- Recreation Vehicles
- Marine

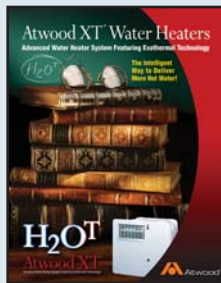

## Atwood XT® Water Heaters

- Recreation Vehicles

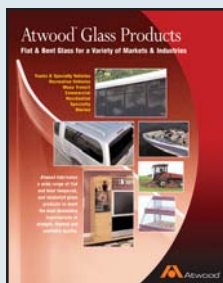

## Atwood® Glass Products

- Trucks/Specialty Vehicles
- Commercial/Residential
- Recreation Vehicles
- Specialty/Marine
- Mass Transit

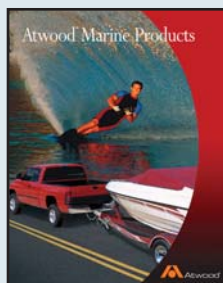

## Atwood® Marine Products

- Marine



## Atwood® CO & LP Gas Alarms

- Recreation Vehicle

## Atwood® Plants

### Atwood Center

*Sales/Marketing, Engineering, Warranty/Service*

1120 North Main Street • Elkhart, IN 46514  
Ph: 574-264-2131 • FAX: 574-262-2550

### Greenbrier Operations

*Ranges, Cooktops, Water Heaters*

6320 Kelly Willis Road • Greenbrier, TN 37073  
Ph: 615-643-4556 • FAX: 615-643-4616

### West Union Operations - Hardware, RV Windows

800 Highway 150 S • West Union, IA 52175  
Ph: 563-422-5641 • FAX: 563-422-5875

### Elkhart Operations - Seating Systems & Hardware

57912 Charlotte Avenue • Elkhart, IN 46517  
Ph: 574-522-7891 • FAX: 574-522-4188

### Creation Group Plant 4 - Windows

23950 County Road 6 • Elkhart, IN 46514  
Ph: 574-206-8566 • FAX: 574-206-8356

### Creation Group Plant 5 - Doors

54347 Highland Blvd. • Elkhart, IN 46514  
Ph: 574-262-9998 • FAX: 574-262-1180

### Antwerp Operations - Glass

5406 U.S. 24 East • Antwerp, OH 45813  
Ph: 419-258-5531 • FAX: 419-258-9411

### Salt Lake Operations

*Furnaces, Gas Alarms, Electronics*

1874 Pioneer Road • Salt Lake City, UT 84104  
Ph: 801-972-4621 • FAX: 801-973-9836

### Kemberly

*Aluminum Extrusions*

201 East Simonton • Elkhart, IN 46514  
Ph: 574-264-4144 • FAX: 574-262-2194

Note: In most cases, dimensions are rounded to 1/8". Drawings and dimensions subject to change without notice. For pricing, contact your Distributor or Atwood Sales Representative. All specifications and illustrations are based on the latest information at the time of publication. Atwood assumes no responsibility for any error in type or print reproduction of specifications in this literature. Due to our policy of continuous improvement, Atwood reserves the right to make changes in price, color, materials, equipment and specifications and to discontinue models at any time without notice.



1120 North Main Street • Elkhart, IN 46514  
PHONE: 574-264-2131 FAX: 574-262-2550  
INTERNET: <http://www.atwoodmobile.com>

